

**A collection of kitchen doors and drawers that fit  
the modular kitchen cabinets**

**ALAZO2AK**

مصنوع على زوفك

# CONTENTS



## 01

INTRODUCTION

## 02

DESIGN  
APPROACH

- 01. CONCEPT
- 02. MOOD BOARD
- 03. DESIGN MODULE

## 03

PATTERN  
DEVELOPMENT

## 04

COLLECTION

- 01. DOORS
- 02. DRAWERS
- 03. RENDER SHOTS

## 05

SPECIFICATIONS

- 01. MATERIAL
- 02. HARDWARE
- 03. RAL COLOR CODE

## 06

WORKSHOP  
DRAWINGS

- 01. DOORS
- 02. DRAWERS

# DESIGN APPROACH

The vision in expressing Egypt's culture, tradition, and holydays; by simulating its aesthetics in a simplified and abstract visual framework. Embracing this vision by enhancing the Egyptian identity in the design. With concerning the Arabesque art as our excellence lie in the soil of our heritage. Presenting the joyful spirit by considering the delightful trendy colors in a modern design.

## THE STORY

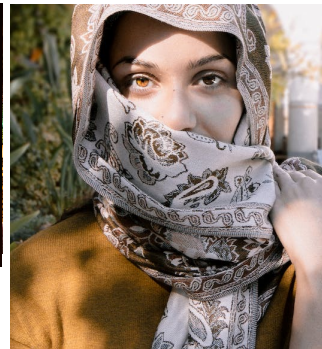
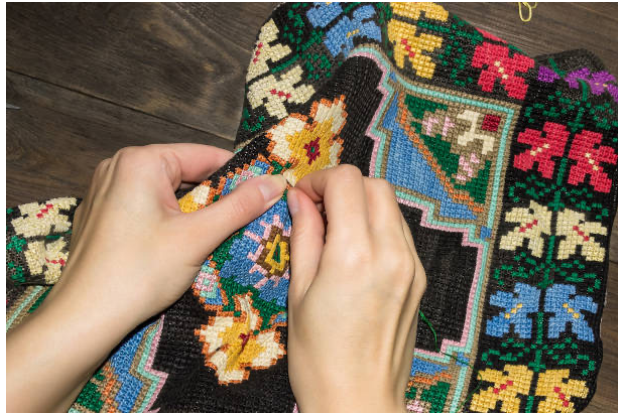
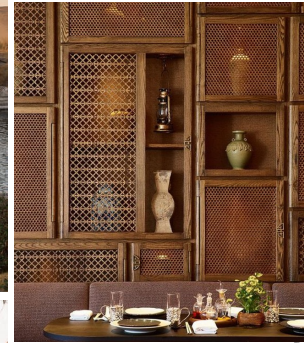

# MOOD BOARD

“ **Ala Zoa’ak** “ is a collection with variety of designs designed on different sizes based on modularity where the user can mix and match upon his taste.

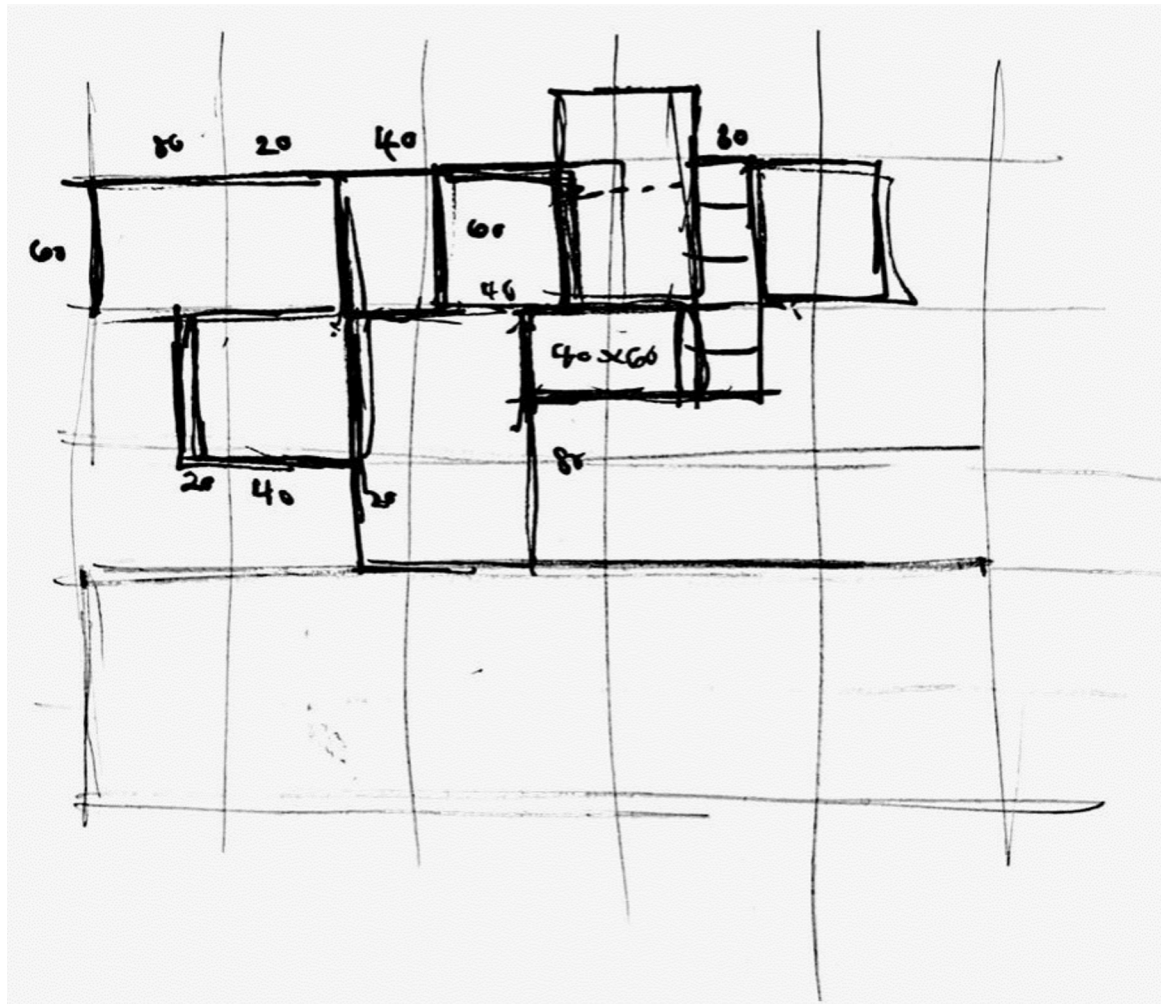

## MODULE DSEIGN

# PATTERN DEVELOPMENT

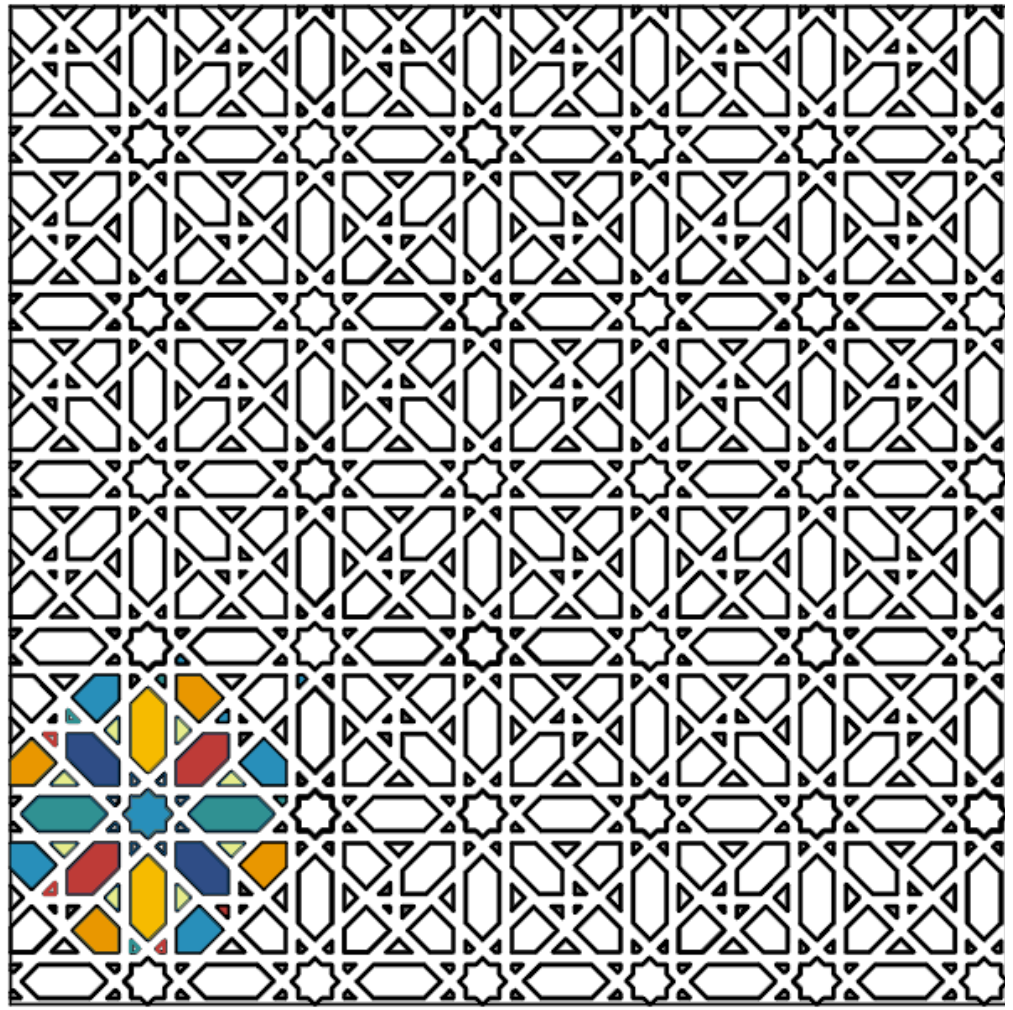
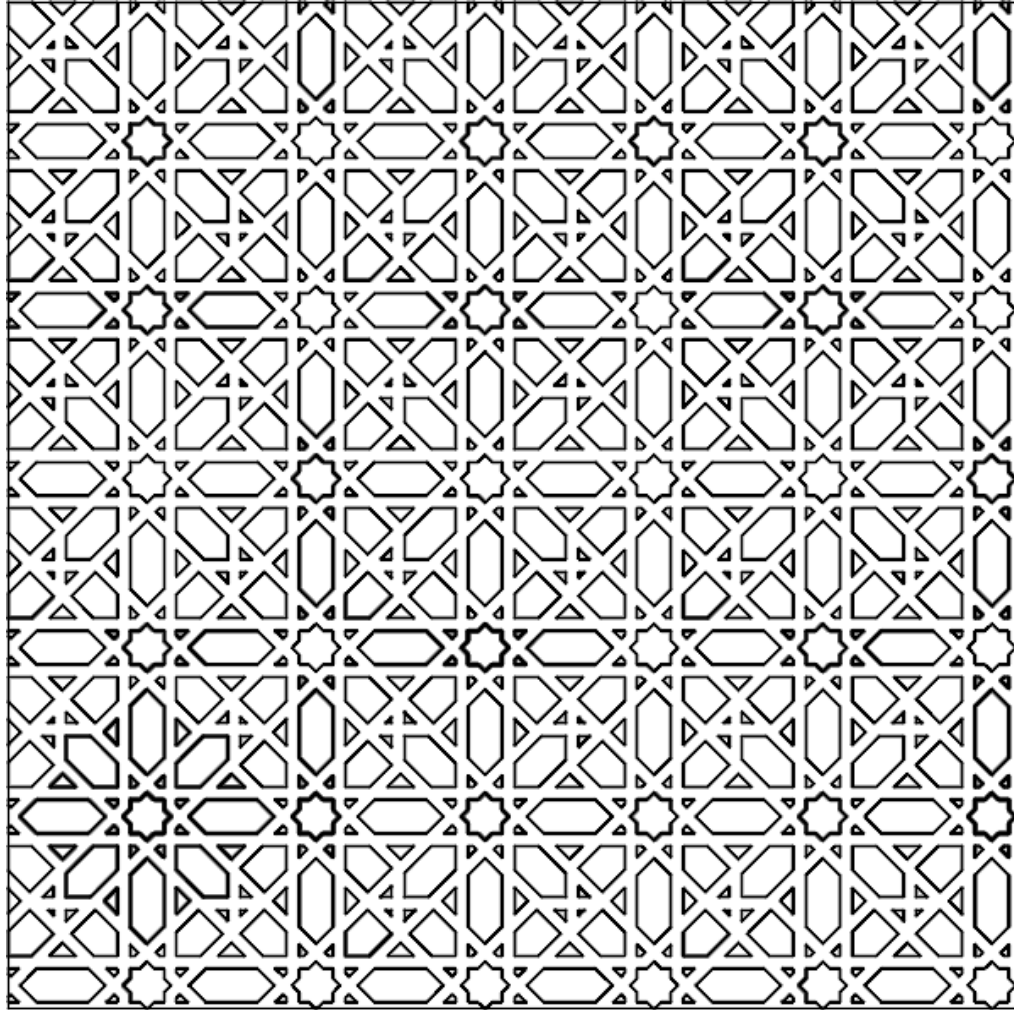

# PATTERN DEVELOPMENT

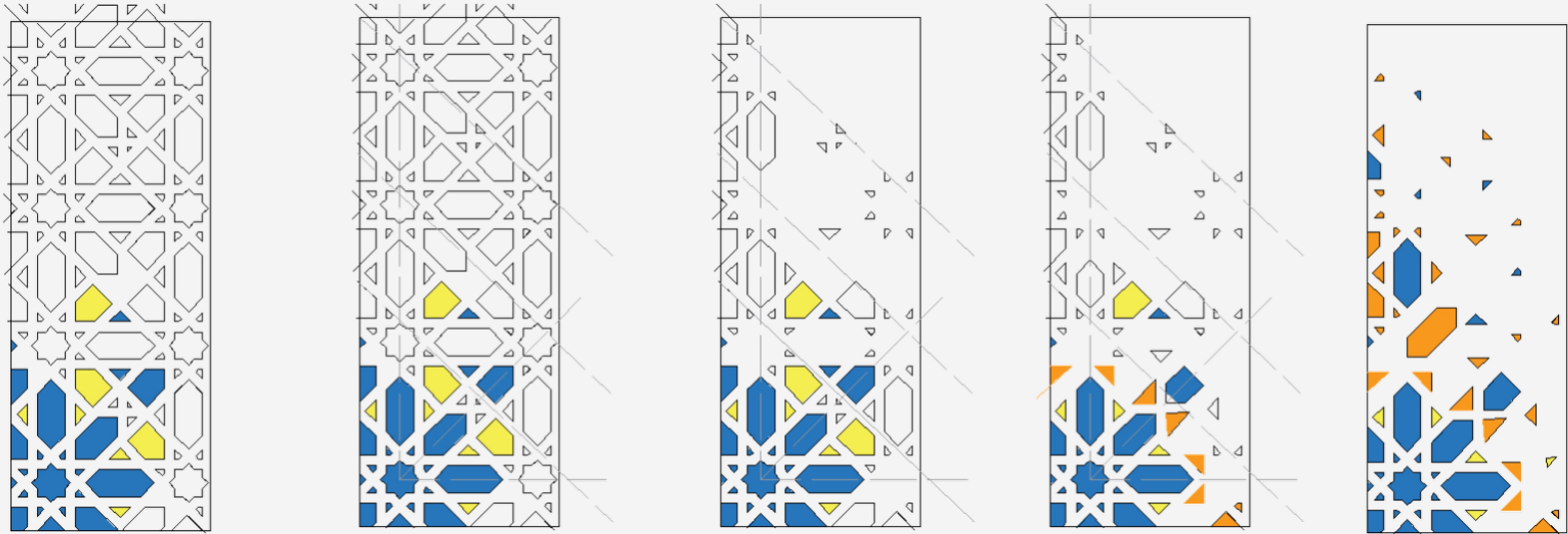

## PATTERN DEVELOPMENT

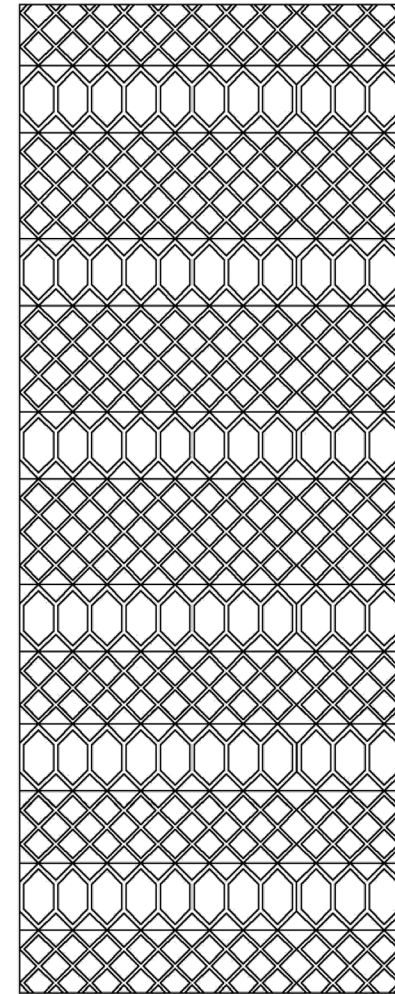
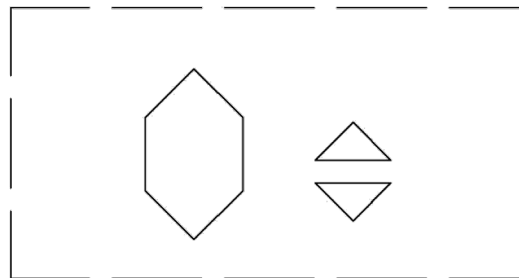
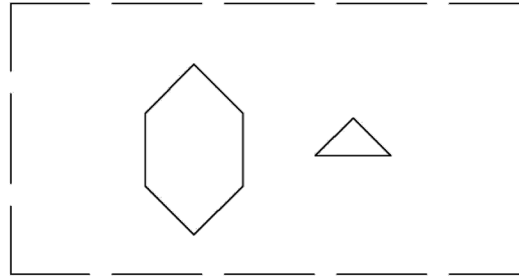
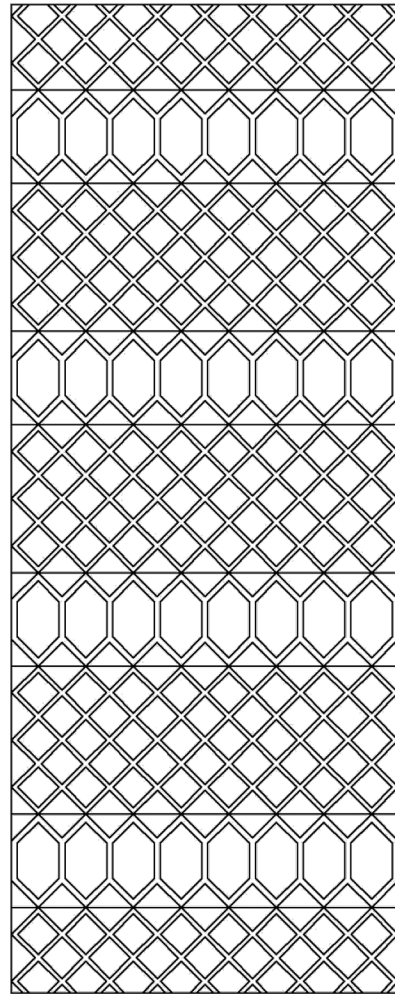

# PATTERN DEVELOPMENT

# COLLECTION

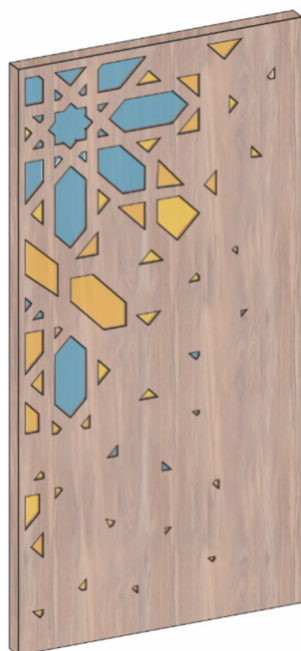

P  
A  
T  
T  
E  
R  
N



M  
E  
S  
H



S  
O  
L  
I  
D



G  
L  
A  
S  
S

## COLLECTION - DOORS

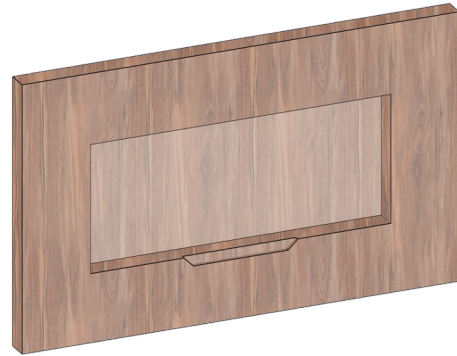

S  
O  
L  
I  
D



M  
E  
S  
H

## COLLECTION - DRAWERS

# RENDER SHOTS





# MATERIAL SPECIFICATIONS

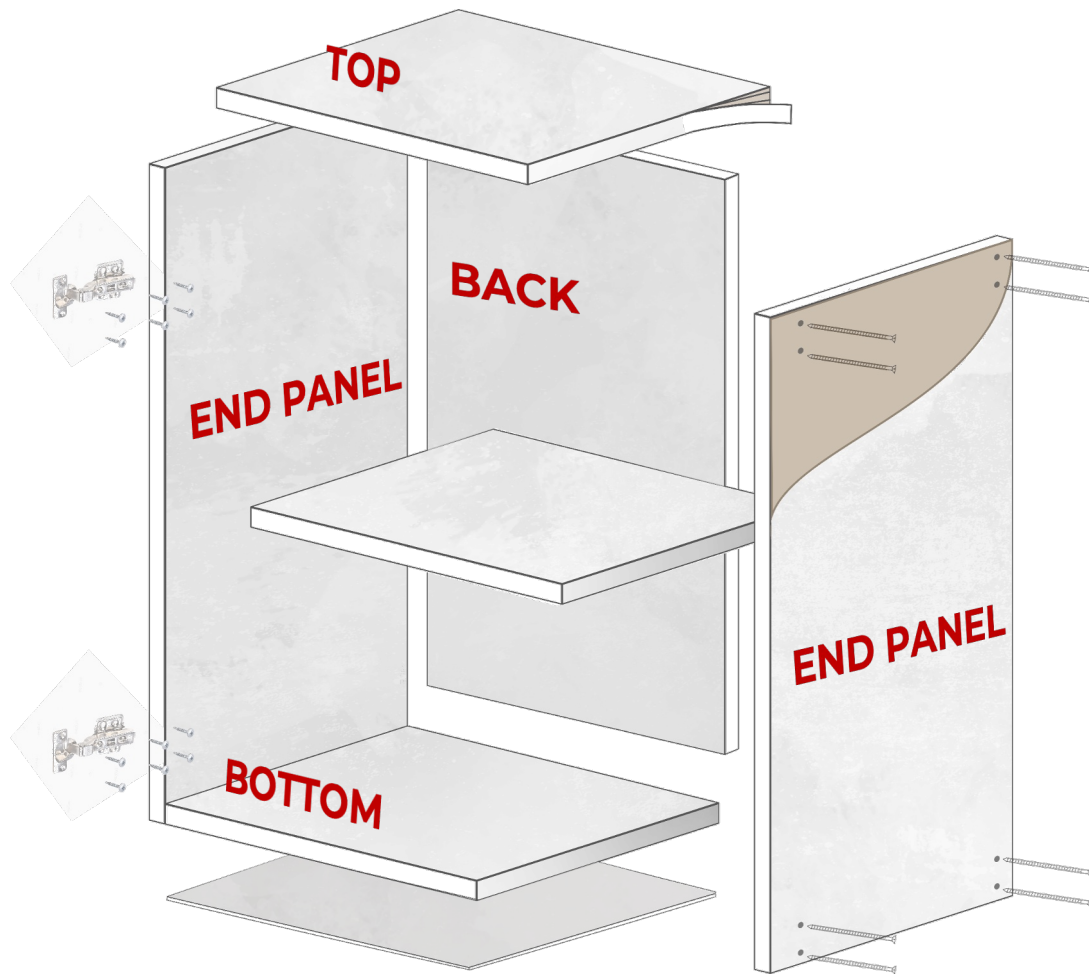

**END PANELS**

18 mm PLYWOOD

**TOP**

18 mm PLYWOOD

**BOTTOM**

18 mm PLYWOOD

**BACK**

8 mm MDF

**PANELS FINIISH**

0.9mm MATTE WHITE

FORMICA – OAK VENER

## MATERIAL SPECIFICATIONS – WALL CABINET

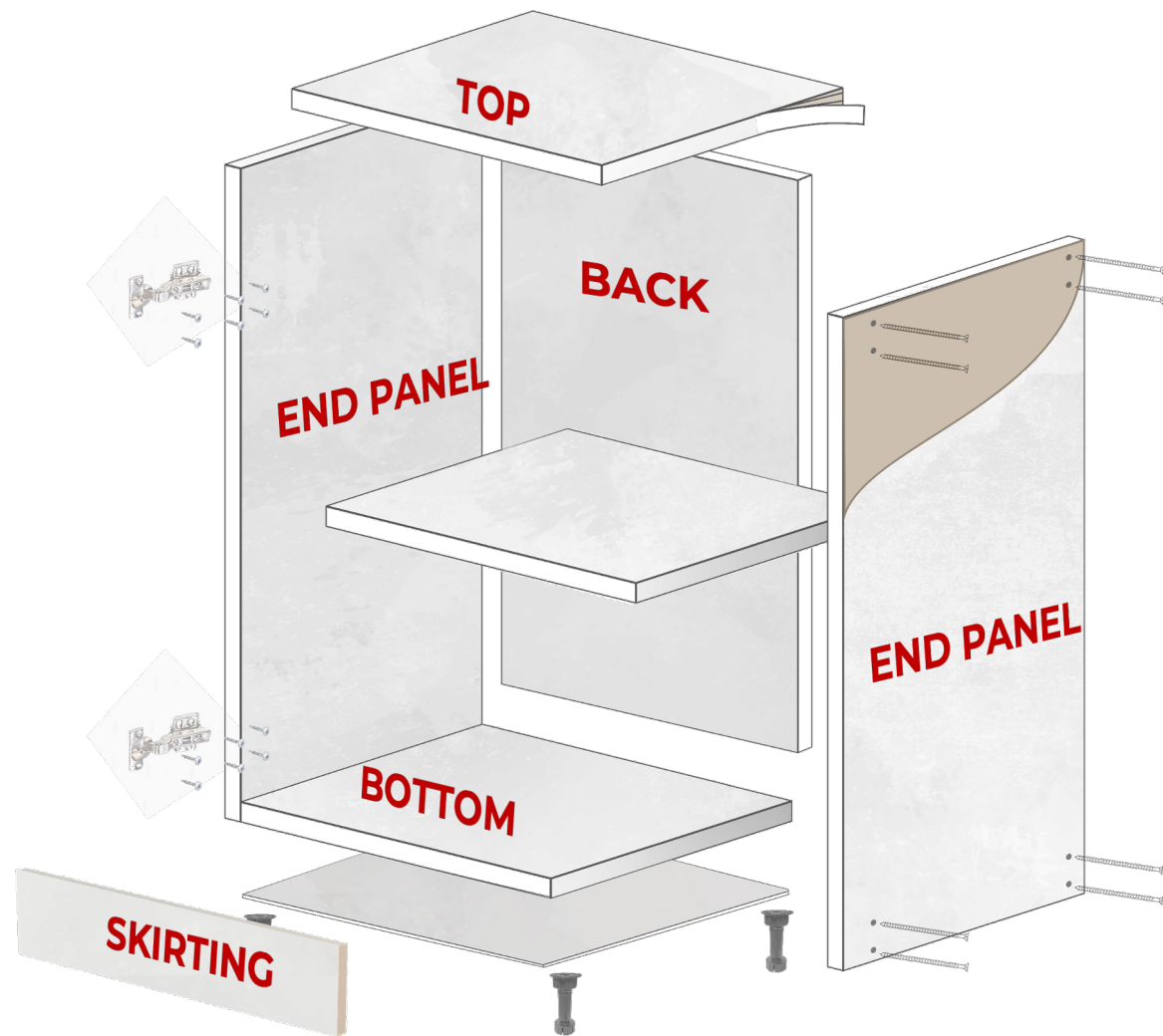

<b>END PANELS</b>	18 mm PLYWOOD
<b>TOP</b>	18 mm PLYWOOD
<b>BOTTOM</b>	18 mm PLYWOOD
<b>BACK</b>	8 mm MDF
<b>SKIRTING</b>	STAINLESS STEEL
<b>PANELS FINIISH</b>	0.9mm MATTE WHITE FORMICA – OAK VENEER

## MATERIAL SPECIFICATIONS – BASE CABINET

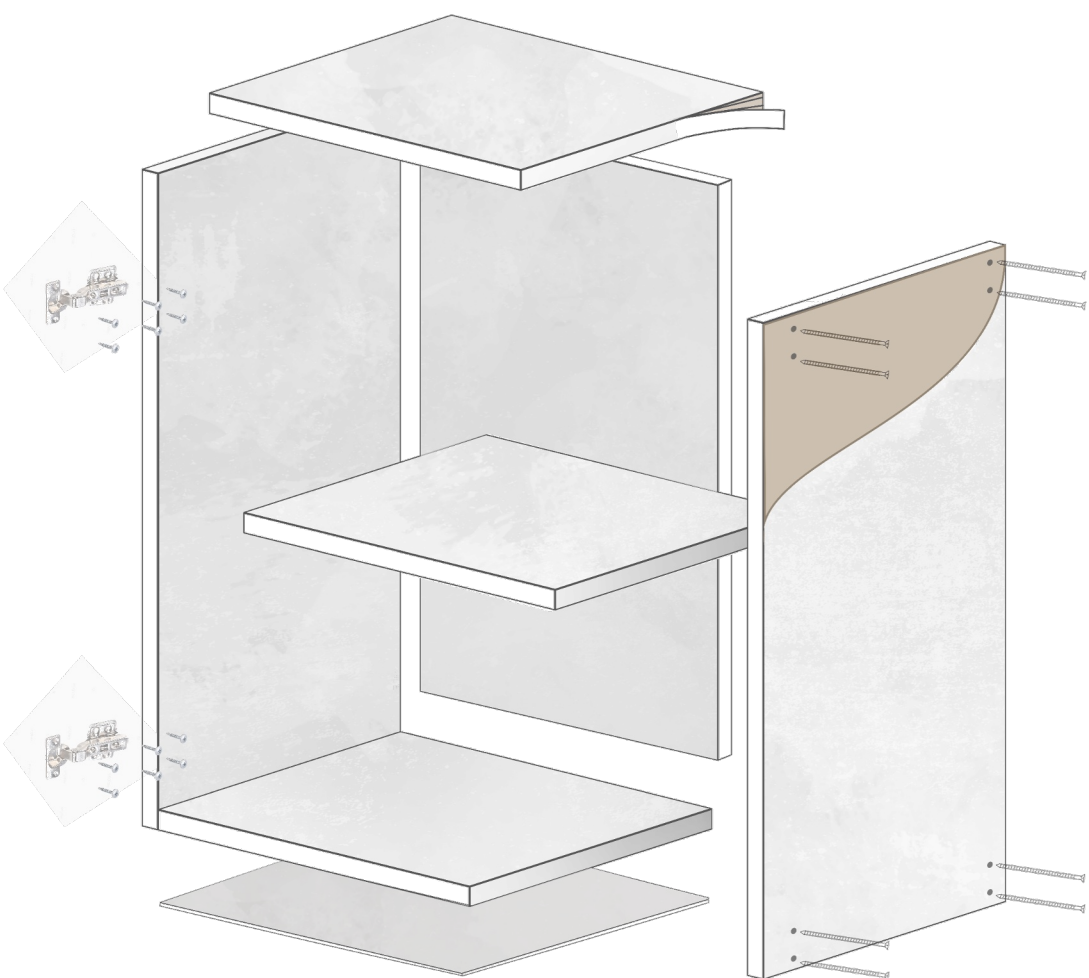

- FINGERPRINT SCREW** 16 PER CABINET (2 every corner)
- HINGE HARDWARE** 2 PER CABINET DOOR
- SCREW** 8 PER CABINET DOOR
- LOWER DRAWER HARDWARE** 2 PER DRAWER (soft close)

# HARDWARE SPECIFICATIONS - CABINET

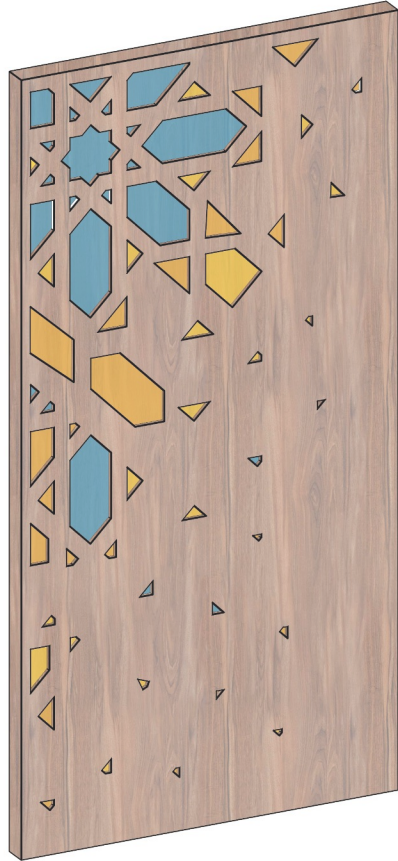

## PATTERN

### PANEL

18mm MDF

### FINISH

0.6mm OAK VENEER - CNC Router

1mm DOCO PAINT + VARNISH

## MATERIAL SPECIFICATIONS - DOOR



**MESH**

- FRAME** 22 mm WHITE WOOD
- FINISH** 0.6mm OAK VENEER
- FILL** 2mm ALUMINUM PERFORATED SHEET  
– CNC Router

## MATERIAL SPECIFICATIONS - DOOR



**SOLID**

**FRAME** 22 mm WHITE WOOD

**FINISH** 0.6mm OAK VENEER

**FILL** 8mm MDF

**FILL FINISH** 0.6mm OAK VENEER

DOCOCO PAINT if COLORED

## MATERIAL SPECIFICATIONS - DOOR



**G L A S S**

**FRAME** 22 mm WHITE WOOD

**FINISH** 0.6mm OAK VENEER

**FILL** 6mm GLASS

## **MATERIAL SPECIFICATIONS - DOOR**

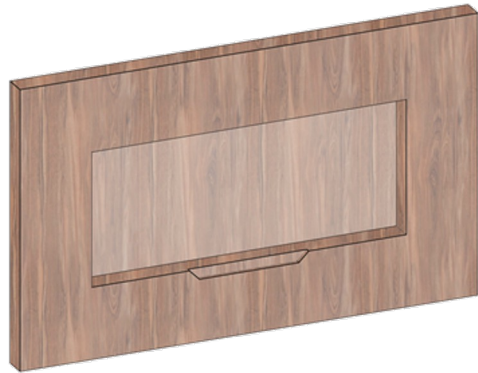

**FRAME** 22 mm WHITE WOOD

**FINISH** 0.6mm OAK VENEER

**FILL** 8mm MDF

**FILL FINISH** 0.6mm OAK VENEER

DOCOPAIN if COLORED

**SOLID**

## MATERIAL SPECIFICATIONS - DRAWERS

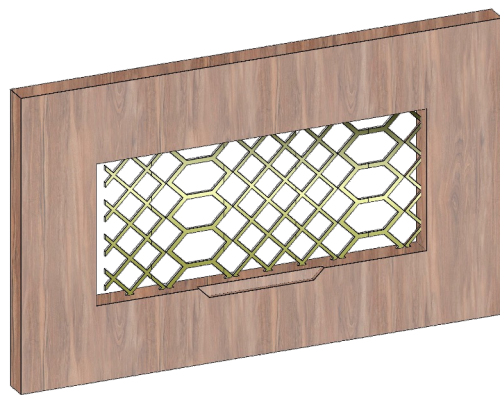

**FRAME**

22 mm White Wood

**FINISH**

0.6mm Oak Veneer

**FILL**

2mm ALUMINUM PERFORATED SHEET

– CNC Router

**MESH**

## **MATERIAL SPECIFICATIONS - DRAWERS**

RAL 085 80 85

RAL 075 70 80

RAL 3020

RAL 5002

RAL 5012

RAL 5018

**DOCO RAL CODE**

# WORKSHOP DRAWINGS



# General Notes

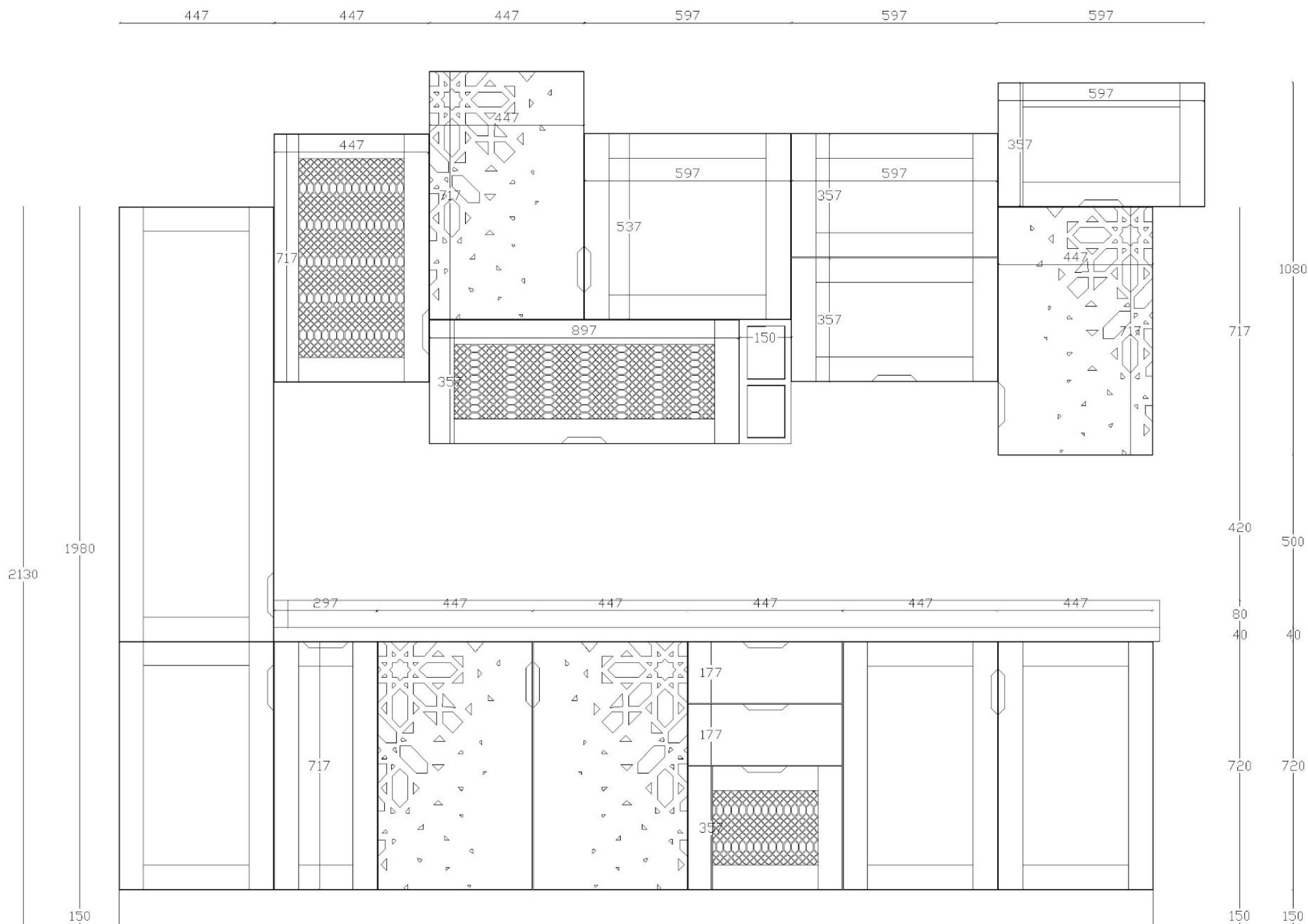

Designer Name: Alaa Ahmed/ Hedaya Elatr  
 Project Name: ALAZO2AK  
 Project category: KITCHEN FRONTS

Scale: 1:100 | Date: ..../.../2023

Sheet title: IRREGULAR ELEVATION  
 Sheet No: ..1.....



General Notes



Designer Name: Alaa Ahmed/ Hedaya Eletr  
 Project Name: ALAZOZAK  
 Project category: KITCHEN FRONTS

Scale | Date  
 ...1: 100 | .../.../2023

Sheet title: REGULAR ELEVATION  
 Sheet No: ..2.....



General Notes

450\*720

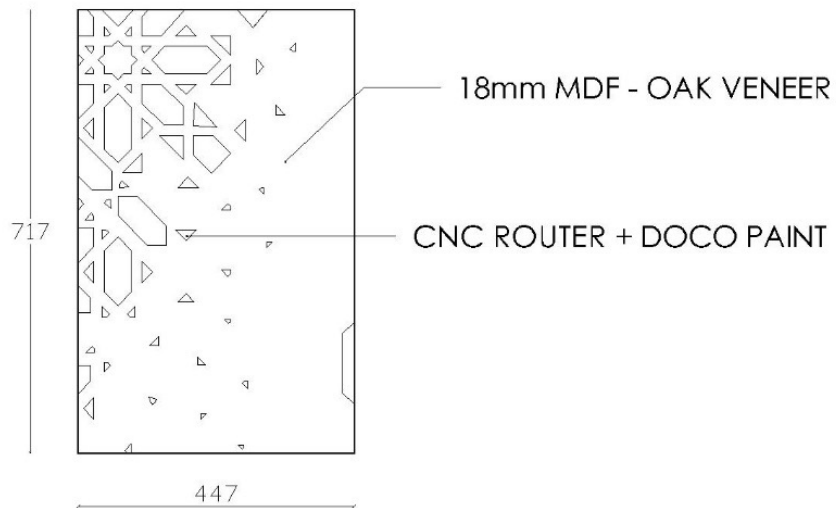

600\*720

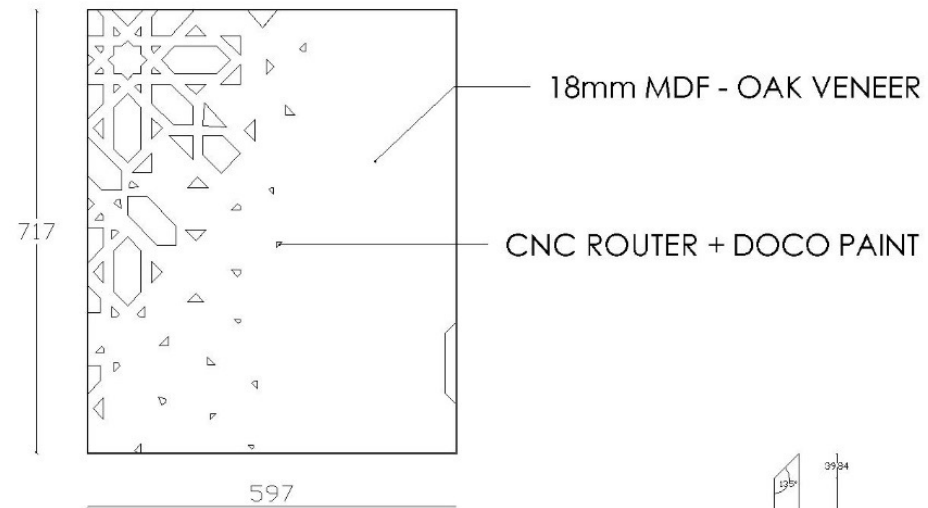

450\*540

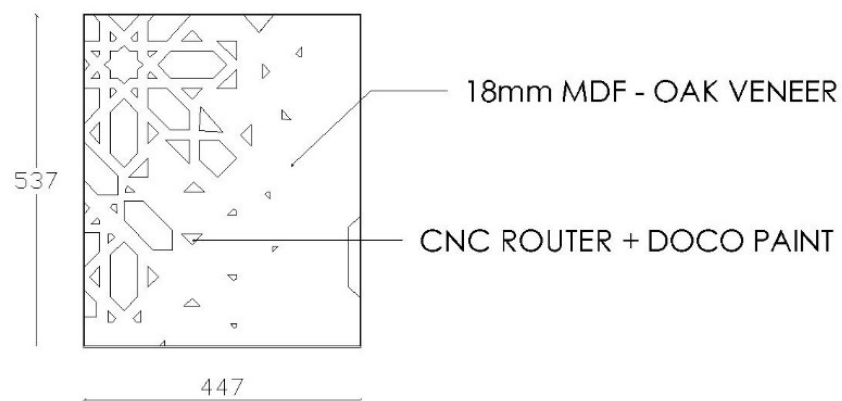

600\*540

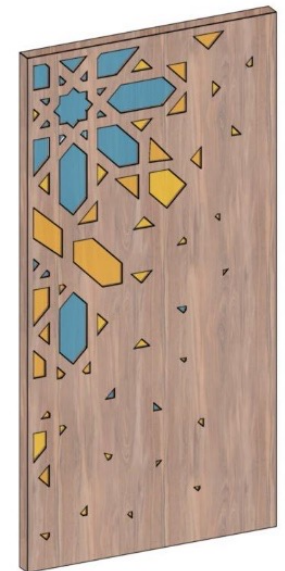
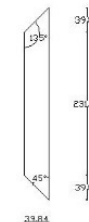
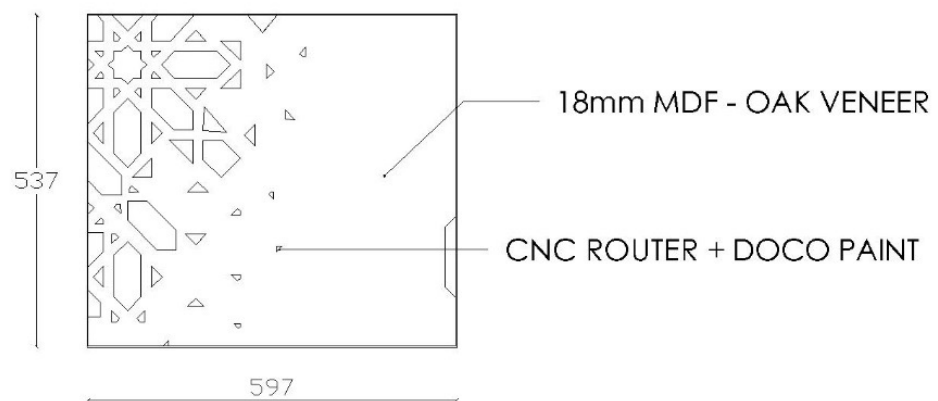

Designer Name: Alaa Ahmed/ Hedaya Elatr  
 Project Name: ALAZO2AK  
 Project category: KITCHEN FRONTS

Scale	Date
..1 : 100	..../..../2023

Sheet title: PATTERN DOORS  
 Sheet No: ..3.....

# SHUTTERS

300\*720

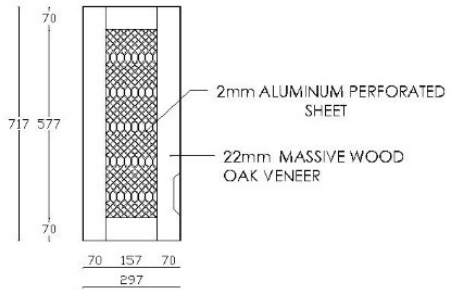

450\*720

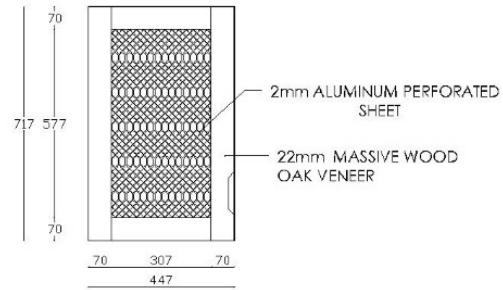

600\*720

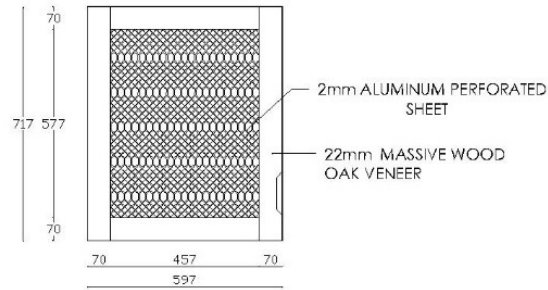

600\*360

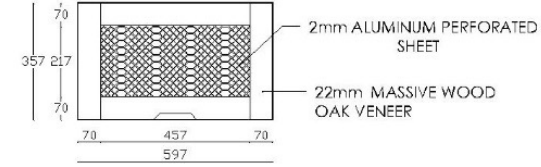

800\*360

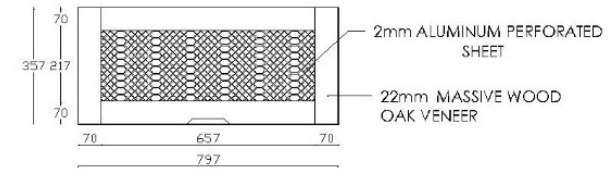

900\*360

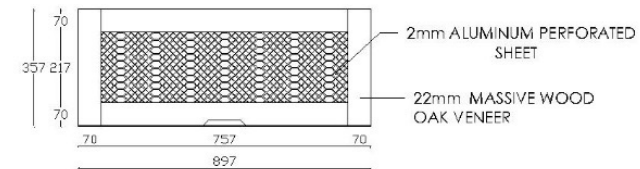

300\*540

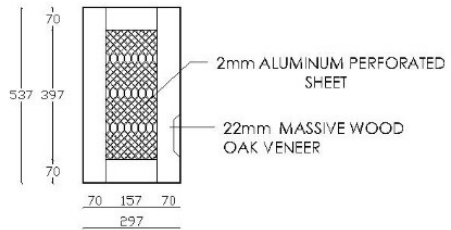

450\*540

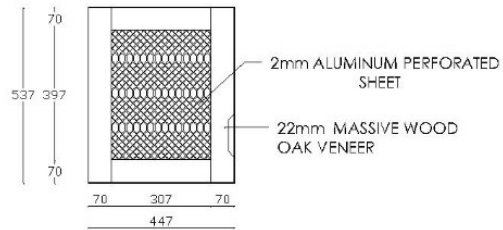

600\*540

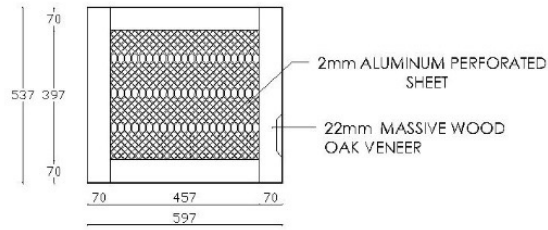

# DRAWERS

300\*360

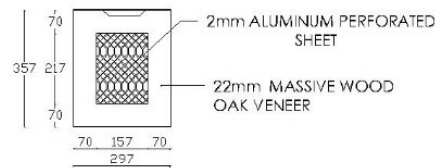

450\*360

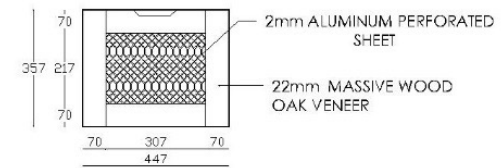

600\*360

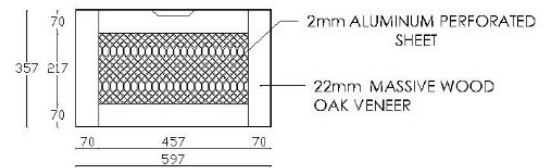

900\*360

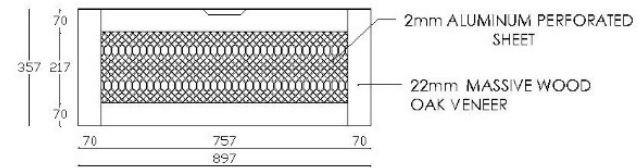

300\*540

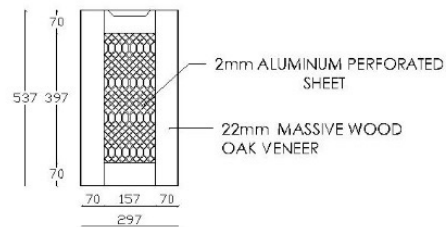

450\*540

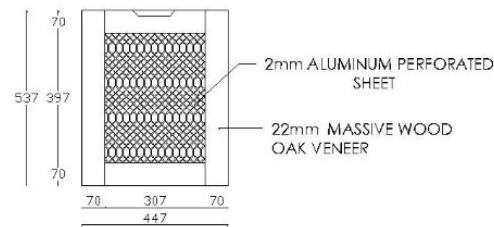

300\*720

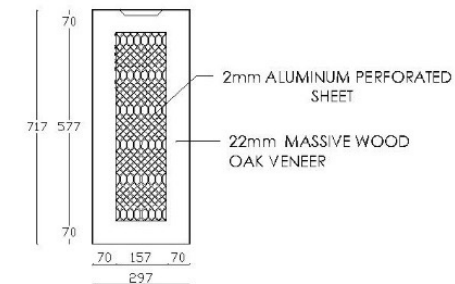

## General Notes



Designer Name: Alaa Ahmed/ Hedaya Elatr

Project Name: ALAZO2AK

Project category: KITCHEN FRONTS

Scale

Date

..1 : 100

..../..../2023

Sheet title: MESH DOORS/DRAWERS

Sheet No: ..4.....



### General Notes



#### 450\*1980

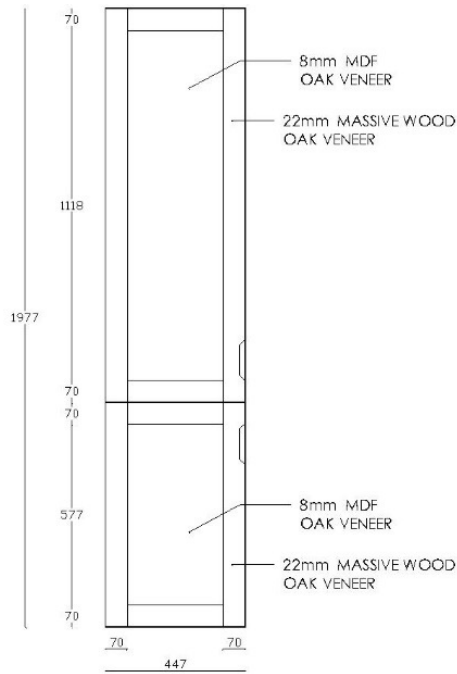

#### 300\*720

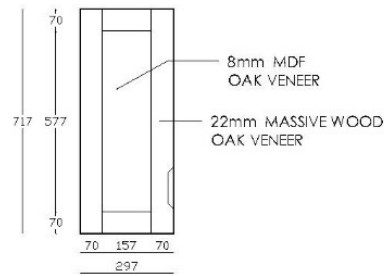

#### 450\*720

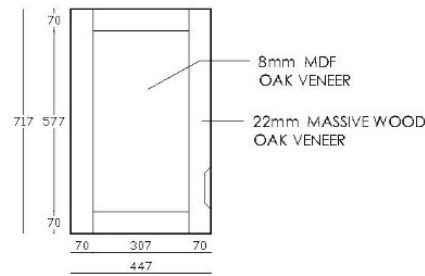

#### 600\*720

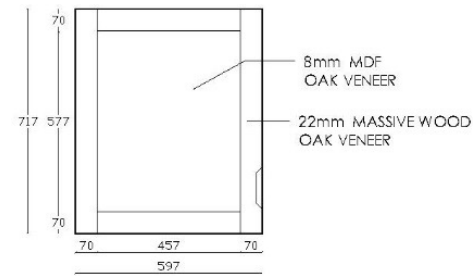

#### 300\*540

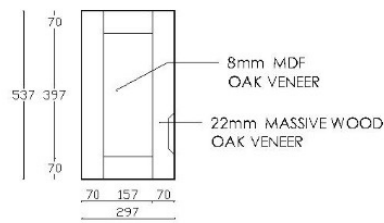

#### 450\*540

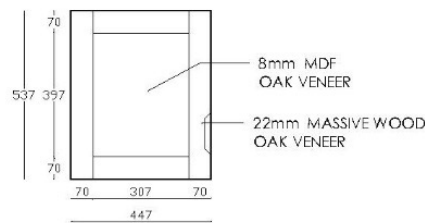

#### 600\*540

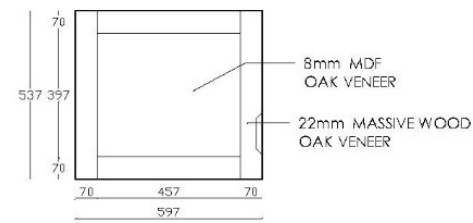

#### 600\*1980

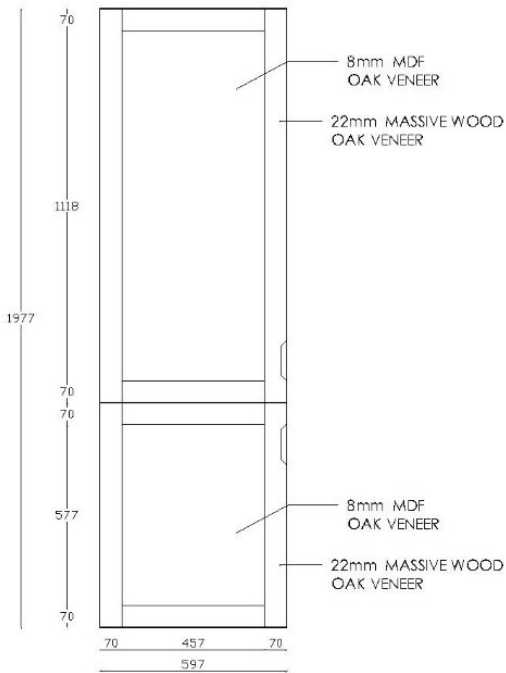

#### 600\*360

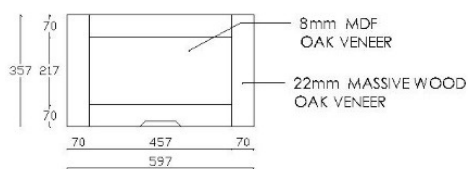

#### 800\*360

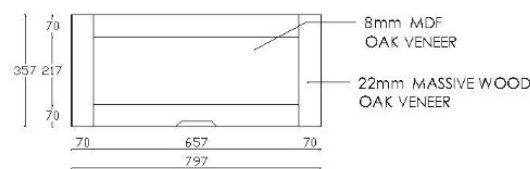

#### 900\*360

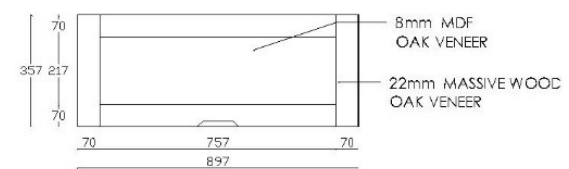

### CORNER

#### 260\*720

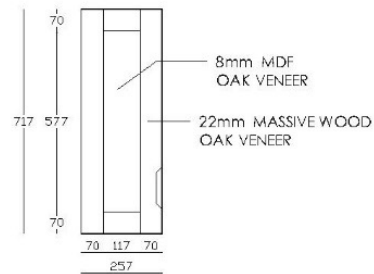

#### 50\*720



#### 330\*720

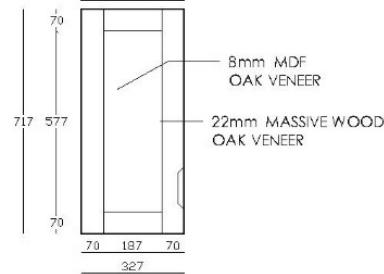

#### 600\*360\*360

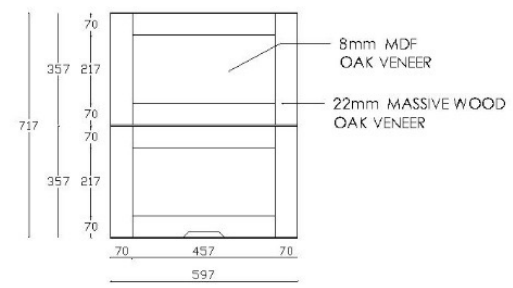

Designer Name: Alaa Ahmed/ Hedaya Elatr  
Project Name: ALAZO2AK  
Project category: KITCHEN FRONTS

Scale | Date  
1 : 100 | .../.../2023

Sheet title: SOLID DOORS  
Sheet No: ..5.....



General Notes

300\*180

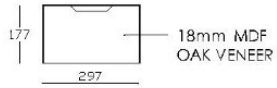

450\*180

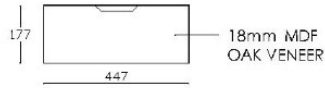

600\*180

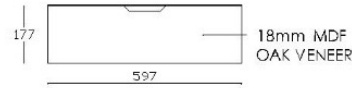

900\*180

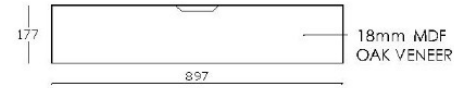

300\*360

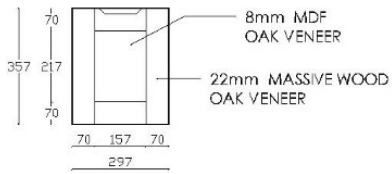

450\*360

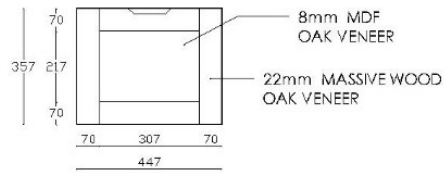

600\*360

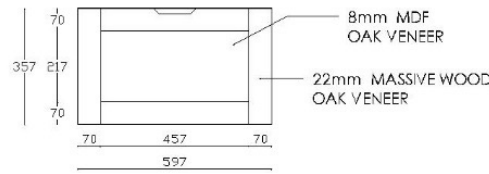

900\*360

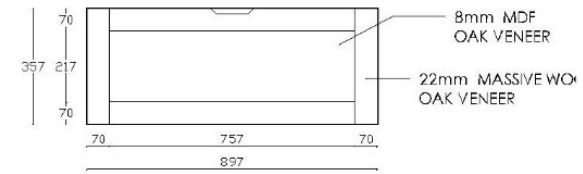

300\*540

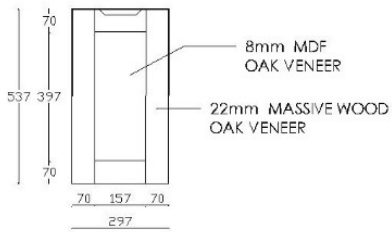

450\*540

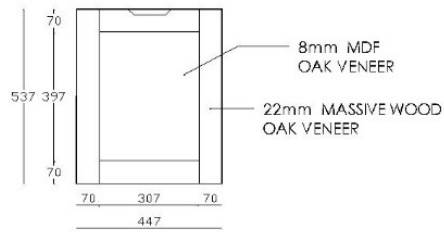

600\*540

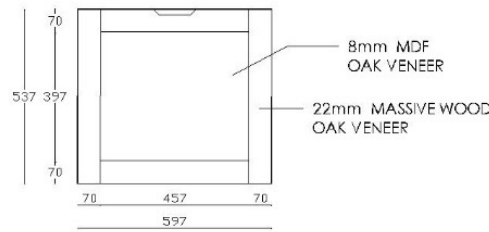

900\*540

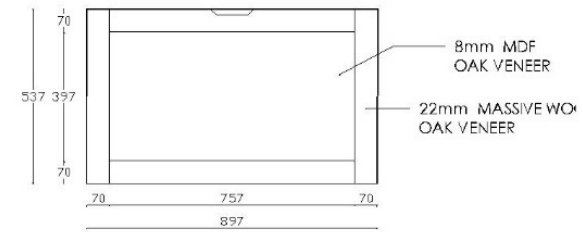

300\*720

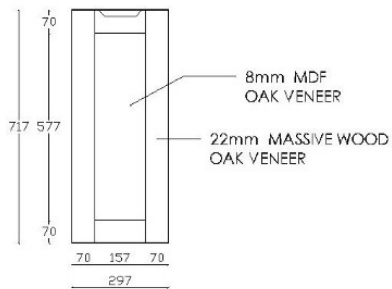

450\*720

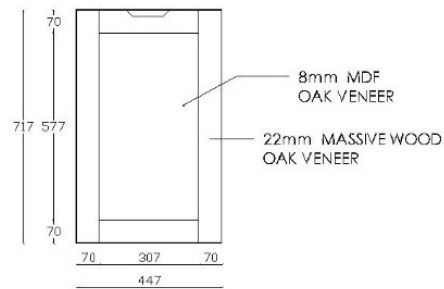

600\*720

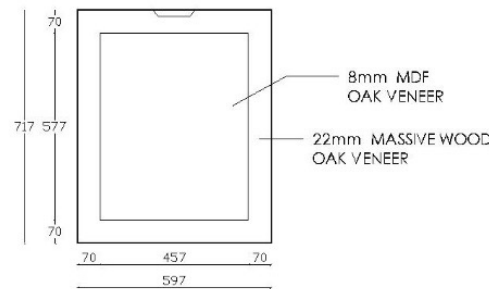

900\*720

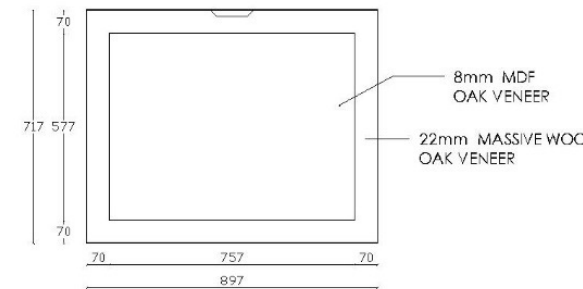

Designer Name: Alaa Ahmed/ Hedaya Elatr

Project Name: ALAZOZAK

Project category: KITCHEN FRONTS

Scale | Date

...1: 100 | .../.../2023

Sheet title: SOLID DRAWERS

Sheet No: ..6.....



## General Notes

300\*720

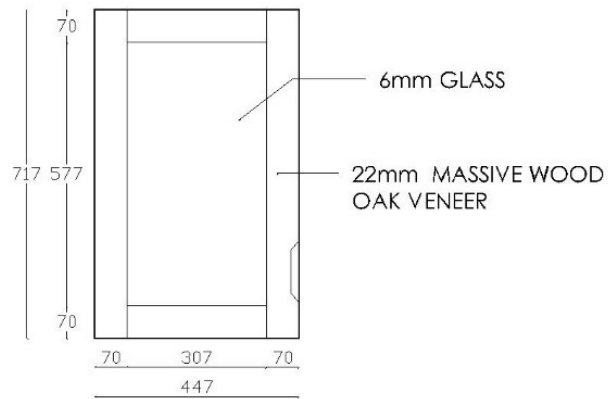

450\*720

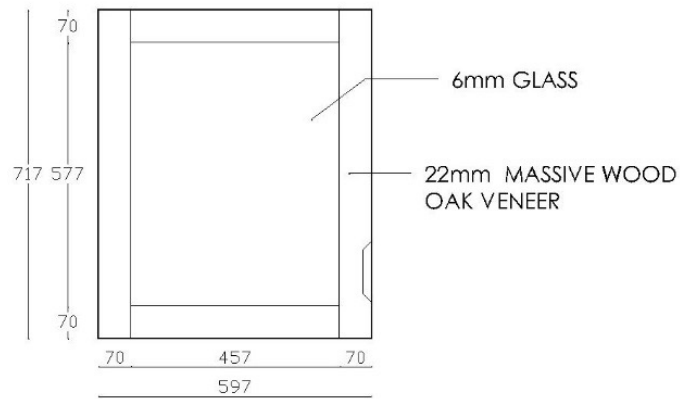

600\*360

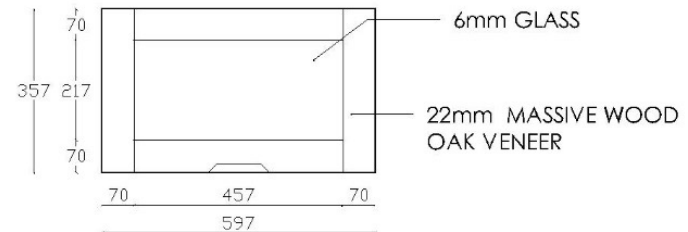

800\*360

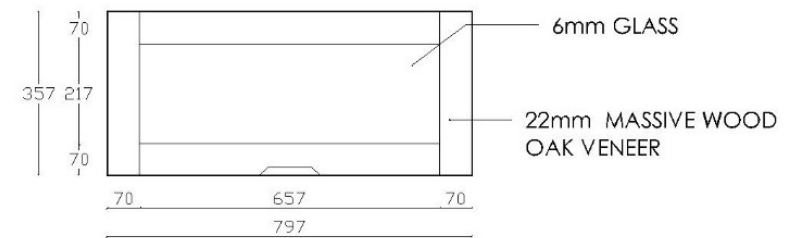

300\*540

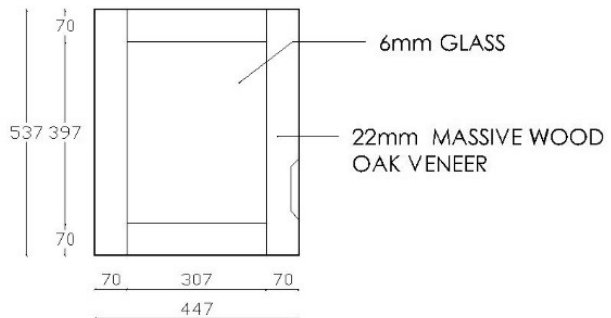

450\*540

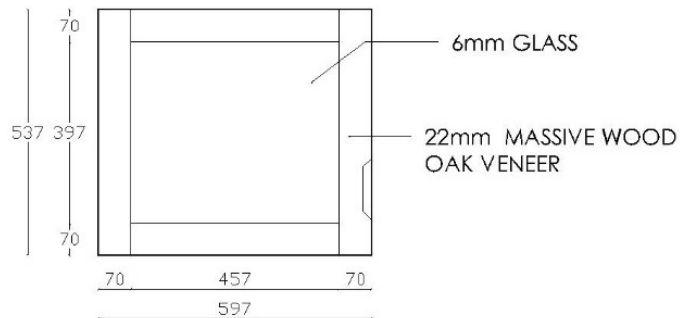

900\*360

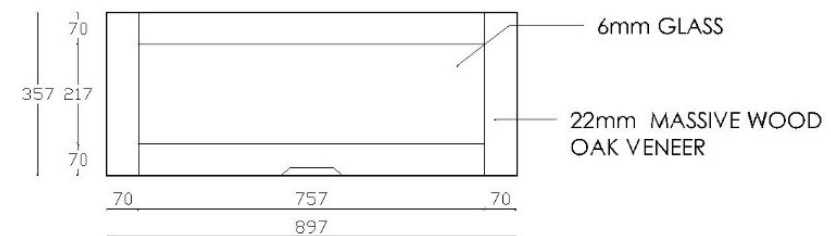

Designer Name: Alaa Ahmed/ Hedaya Elatr  
Project Name: ALAZO2AK  
Project category: KITCHEN FRONTS

Scale | Date  
..1 : 100 | .... / ... / 2023

Sheet title: GLASS DOORS  
Sheet No: ..7.....



HEDAYA ELETR

hedayalaa@gmail.com  
01555519689



ALAA AHMED

alaa.a.elsonny@gmail.com  
01096156880

